

**NECOSTEEL**®

RVS BESLAG

*ijzersterk merk van Ivana*

# RVS deurgrepen

CATALOGUS

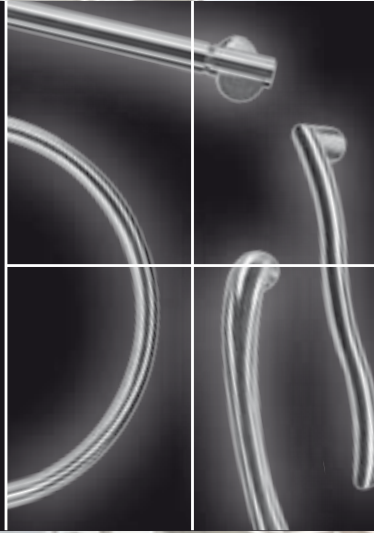

 **IVANA**®

T-GREEP  
TYPE 094

Pagina 5

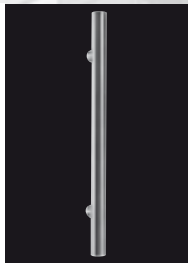

U-GREEP  
TYPE 091

Pagina 6



T-SCHUIN GREEP  
TYPE 083

Pagina 7

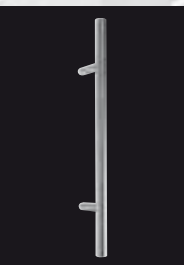

U90-GREEP  
TYPE 085

Pagina 8



DOORGEZETTE GREEP  
TYPE 090

Pagina 9



V-GREEP  
TYPE 084

Pagina 10



HALFRONDE GREEP  
TYPE 093

Pagina 11



S-GREEP  
TYPE 082

Pagina 12



T-GEBOGEN GREEP  
TYPE 080

Pagina 13



U GEBOGEN GREEP  
TYPE 070

Pagina 14





**U90 GEBOGEN GREEP  
 TYPE 071**

Pagina 15



**T-DOORGEZETTE  
 GREEP TYPE 081**

Pagina 16

**WP-GREPEN  
 TYPE 077**

Pagina 16

**GEBOGEN  
 RECHTE GREEP**

Pagina 17



**GEBOGEN  
 GEKANTELDE GREEP**  
 Pagina 17

**T-KOKER GREEP**

Pagina 18

**U90-KOKER GREPEN**

Pagina 19

**TYPE 075**

Pagina 20



**TYPE 095**

Pagina 20



**TYPE 078**

Pagina 21

**TYPE 074**

Pagina 21

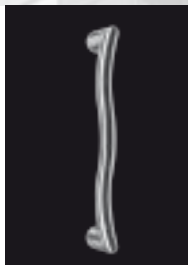

**TYPE 073**

Pagina 22



**TYPE 087**

Pagina 22



**TYPE 072**

Pagina 23

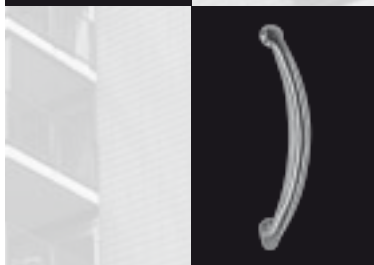

**DRUKVERDEEL-  
ROZETTEN  
OPSCHROEFROZETTEN**

Pagina 23

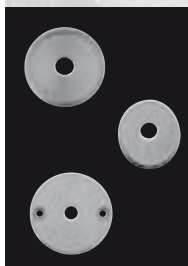

**BEVESTIGINGEN**

Pagina 24/25

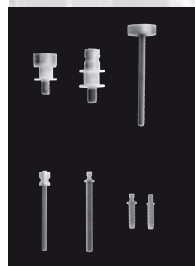

**ALGEMENE  
INFORMATIE**

Pagina 26



**BESTELFORMULIER  
MAATWERK**

Pagina 27

# DEURGREPEN

## T-GREEP, TYPE 094

Als de A-maat het aanbevolen maximum overschrijdt, adviseren wij een extra steun toe te passen.

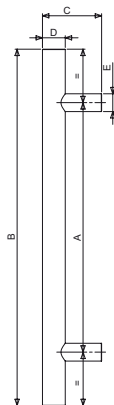
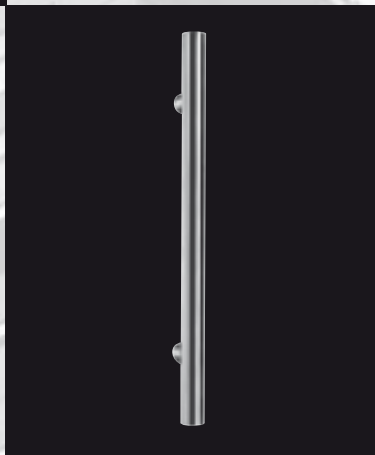

### STANDAARD DIA 16MM

|            | A    | B   | C   | D  | E  | bevestiging | boorgat |
|------------|------|-----|-----|----|----|-------------|---------|
| 1003045500 | stuk | 160 | 260 | 55 | 16 | 14          | M6 Ø 10 |
| 1003045501 | paar | 160 | 260 | 55 | 16 | 14          | M6 Ø 10 |
| 1003045502 | stuk | 190 | 290 | 55 | 16 | 14          | M6 Ø 10 |
| 1003045503 | paar | 190 | 290 | 55 | 16 | 14          | M6 Ø 10 |
| 1003045504 | stuk | 191 | 380 | 55 | 16 | 14          | M6 Ø 10 |
| 1003045505 | paar | 191 | 380 | 55 | 16 | 14          | M6 Ø 10 |
| 1003045506 | stuk | 320 | 420 | 55 | 16 | 14          | M6 Ø 10 |
| 1003045507 | paar | 320 | 420 | 55 | 16 | 14          | M6 Ø 10 |

### STANDAARD DIA 19MM

|            | A    | B   | C   | D  | E  | bevestiging | boorgat |
|------------|------|-----|-----|----|----|-------------|---------|
| 1003045510 | stuk | 200 | 350 | 54 | 19 | 18          | M6 Ø 10 |
| 1003045511 | paar | 200 | 350 | 54 | 19 | 18          | M6 Ø 10 |
| 1003045512 | stuk | 300 | 450 | 54 | 19 | 18          | M6 Ø 10 |
| 1003045513 | paar | 300 | 450 | 54 | 19 | 18          | M6 Ø 10 |
| 1003045514 | stuk | 500 | 650 | 54 | 19 | 18          | M6 Ø 10 |
| 1003045515 | paar | 500 | 650 | 54 | 19 | 18          | M6 Ø 10 |

### MAATWERK DIA 19MM (• Bestelformulier, zie achter in brochure)

| maat A        | maat B   | maat C | maat D | maat E | bevestiging | boorgat |
|---------------|----------|--------|--------|--------|-------------|---------|
| tot max. 1000 | variabel | 54     | 19     | 18     | M6          | Ø 10    |

### STANDAARD DIA 25MM

|            | A    | B   | C   | D  | E  | bevestiging | boorgat |
|------------|------|-----|-----|----|----|-------------|---------|
| 1003045520 | stuk | 300 | 450 | 68 | 25 | 20          | M8 Ø 12 |
| 1003045521 | paar | 300 | 450 | 68 | 25 | 20          | M8 Ø 12 |
| 1003045522 | stuk | 500 | 700 | 68 | 25 | 20          | M8 Ø 12 |
| 1003045523 | paar | 500 | 700 | 68 | 25 | 20          | M8 Ø 12 |

### MAATWERK DIA 25MM (• Bestelformulier, zie achter in brochure)

| maat A        | maat B   | maat C | maat D | maat E | bevestiging | boorgat |
|---------------|----------|--------|--------|--------|-------------|---------|
| tot max. 1500 | variabel | 68     | 25     | 20     | M8          | Ø 12    |

### STANDAARD DIA 32MM

|            | A    | B   | C   | D  | E  | bevestiging | boorgat |
|------------|------|-----|-----|----|----|-------------|---------|
| 1003065520 | stuk | 300 | 500 | 72 | 32 | 25          | M8 Ø 12 |
| 1003065521 | paar | 300 | 500 | 72 | 32 | 25          | M8 Ø 12 |

### MAATWERK DIA 32MM (• Bestelformulier, zie achter in brochure)

| maat A        | maat B   | maat C | maat D | maat E | bevestiging | boorgat |
|---------------|----------|--------|--------|--------|-------------|---------|
| tot max. 2000 | variabel | 72     | 32     | 25     | M8          | Ø 12    |

### MAATWERK DIA 38MM (• Bestelformulier, zie achter in brochure)

| maat A        | maat B   | maat C | maat D | maat E | bevestiging | boorgat |
|---------------|----------|--------|--------|--------|-------------|---------|
| tot max. 2400 | variabel | 90     | 38     | 30     | M8          | Ø 12    |

### MAATWERK DIA 50MM (• Bestelformulier, zie achter in brochure)

| maat A        | maat B   | maat C | maat D | maat E | bevestiging | boorgat |
|---------------|----------|--------|--------|--------|-------------|---------|
| tot max. 2800 | variabel | 102    | 50     | 30     | M8          | Ø 12    |

# DEURGREPEN

## U-GREEP, TYPE 091

**NECOSTEEL**<sup>®</sup>  
RVS BESLAG  
opendek merk van vanaa

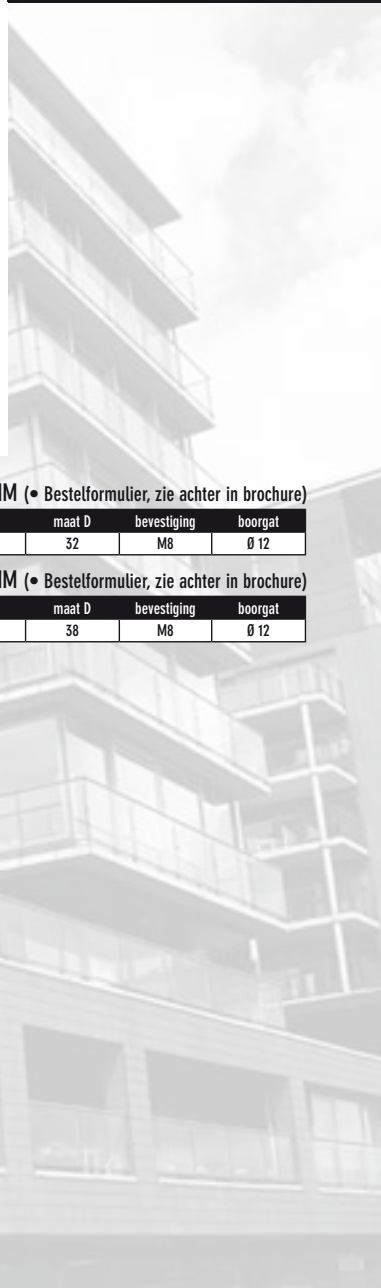

### STANDAARD DIA 16MM

|            |      | A   | C  | D  | bevestiging | boorgat |
|------------|------|-----|----|----|-------------|---------|
| 1003045590 | stuk | 200 | 55 | 16 | M6          | Ø 10    |
| 1003045591 | paar | 200 | 55 | 16 | M6          | Ø 10    |
| 1003045592 | stuk | 300 | 55 | 16 | M6          | Ø 10    |
| 1003045593 | paar | 300 | 55 | 16 | M6          | Ø 10    |
| 1003045594 | stuk | 400 | 55 | 16 | M6          | Ø 10    |
| 1003045595 | paar | 400 | 55 | 16 | M6          | Ø 10    |

### MAATWERK DIA 32MM (• Bestelformulier, zie achter in brochure)

| maat A        | maat C | maat D | bevestiging | boorgat |
|---------------|--------|--------|-------------|---------|
| tot max. 2000 | 80     | 32     | M8          | Ø 12    |

### STANDAARD DIA 19MM

|            |      | A   | C  | D  | bevestiging | boorgat |
|------------|------|-----|----|----|-------------|---------|
| 1003045596 | stuk | 300 | 65 | 19 | M6          | Ø 10    |
| 1003045597 | paar | 300 | 65 | 19 | M6          | Ø 10    |
| 1003045598 | stuk | 400 | 65 | 19 | M6          | Ø 10    |
| 1003045599 | paar | 400 | 65 | 19 | M6          | Ø 10    |

### MAATWERK DIA 38MM (• Bestelformulier, zie achter in brochure)

| maat A        | maat C | maat D | bevestiging | boorgat |
|---------------|--------|--------|-------------|---------|
| tot max. 2400 | 90     | 38     | M8          | Ø 12    |

### MAATWERK DIA 19MM (• Bestelformulier, zie achter in brochure)

| maat A        | maat C | maat D | bevestiging | boorgat |
|---------------|--------|--------|-------------|---------|
| tot max. 1000 | 65     | 19     | M6          | Ø 10    |

### STANDAARD DIA 25MM

|            |      | A   | C  | D  | bevestiging | boorgat |
|------------|------|-----|----|----|-------------|---------|
| 1003045600 | stuk | 300 | 70 | 25 | M8          | Ø 12    |
| 1003045601 | paar | 300 | 70 | 25 | M8          | Ø 12    |
| 1003045602 | stuk | 400 | 70 | 25 | M8          | Ø 12    |
| 1003045603 | paar | 400 | 70 | 25 | M8          | Ø 12    |

### MAATWERK DIA 25MM (• Bestelformulier, zie achter in brochure)

| maat A        | maat C | maat D | bevestiging | boorgat |
|---------------|--------|--------|-------------|---------|
| tot max. 1500 | 75     | 25     | M8          | Ø 12    |

### STANDAARD DIA 32MM

|            |      | A   | C  | D  | bevestiging | boorgat |
|------------|------|-----|----|----|-------------|---------|
| 1003045610 | stuk | 300 | 80 | 32 | M8          | Ø 12    |
| 1003045611 | paar | 300 | 80 | 32 | M8          | Ø 12    |

# DEURGREPEN

## T- SCHUIN GREEP, TYPE 083

Bij montage op hout of kunststof adviseren wij een drukverdeelrozet te gebruiken.

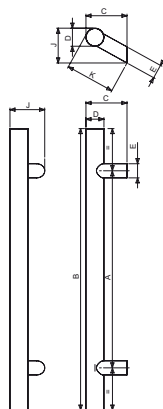

### STANDAARD DIA 25MM

|            |      | A   | B   | C  | D  | E  | J  | bevestiging | boorgat |
|------------|------|-----|-----|----|----|----|----|-------------|---------|
| 1003045760 | stuk | 300 | 450 | 91 | 25 | 20 | 71 | M10         | Ø 14    |
| 1003045761 | paar | 300 | 450 | 91 | 25 | 20 | 71 | M10         | Ø 14    |

### MAATWERK DIA 25MM (• Bestelformulier, zie achter in brochure)

| maat A        | maat B   | maat C | maat D | maat E | maat J | bevestiging | boorgat |
|---------------|----------|--------|--------|--------|--------|-------------|---------|
| tot max. 1000 | variabel | 91     | 25     | 20     | 71     | M10         | Ø 14    |

### STANDAARD DIA 32MM

|            |      | A   | B   | C  | D  | E  | J  | bevestiging | boorgat |
|------------|------|-----|-----|----|----|----|----|-------------|---------|
| 1003045770 | stuk | 300 | 450 | 95 | 32 | 25 | 75 | M10         | Ø 14    |
| 1003045771 | paar | 300 | 450 | 95 | 32 | 25 | 75 | M10         | Ø 14    |

### MAATWERK DIA 32MM (• Bestelformulier, zie achter in brochure)

| maat A        | maat B   | maat C | maat D | maat E | maat J | bevestiging | boorgat |
|---------------|----------|--------|--------|--------|--------|-------------|---------|
| tot max. 1500 | variabel | 95     | 32     | 25     | 75     | M10         | Ø 14    |

### MAATWERK DIA 38MM (• Bestelformulier, zie achter in brochure)

| maat A        | maat B   | maat C | maat D | maat E | maat J | bevestiging | boorgat |
|---------------|----------|--------|--------|--------|--------|-------------|---------|
| tot max. 1800 | variabel | 98     | 38     | 30     | 82     | M10         | Ø 14    |

### MAATWERK DIA 50MM (• Bestelformulier, zie achter in brochure)

| maat A        | maat B   | maat C | maat D | maat E | maat J | bevestiging | boorgat |
|---------------|----------|--------|--------|--------|--------|-------------|---------|
| tot max. 2000 | variabel | 115    | 50     | 30     | 94     | M10         | Ø 14    |

# DEURGREPEN

## U90-GREEP, TYPE 085

**NECOSTEEL**<sup>®</sup>  
RVS BESLAG  
spannerk merk voor rvaag

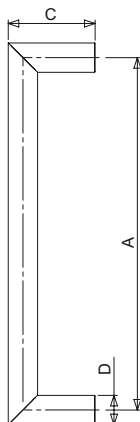

### STANDAARD DIA 19MM

|            |      | A   | C  | D  | bevestiging | boorgat |
|------------|------|-----|----|----|-------------|---------|
| 1003045670 | stuk | 300 | 70 | 19 | M6          | Ø 10    |
| 1003045671 | paar | 300 | 70 | 19 | M6          | Ø 10    |

### MAATWERK DIA 19MM (• Bestelformulier, zie achter in brochure)

| maat A        | maat C | maat D | bevestiging | boorgat |
|---------------|--------|--------|-------------|---------|
| tot max. 1000 | 65     | 19     | M6          | Ø 10    |

### STANDAARD DIA 25MM

|            |      | A   | C  | D  | bevestiging | boorgat |
|------------|------|-----|----|----|-------------|---------|
| 1003045680 | stuk | 300 | 74 | 25 | M8          | Ø 12    |
| 1003045681 | paar | 300 | 74 | 25 | M8          | Ø 12    |

### MAATWERK DIA 25MM (• Bestelformulier, zie achter in brochure)

| maat A        | maat C | maat D | bevestiging | boorgat |
|---------------|--------|--------|-------------|---------|
| tot max. 1500 | 75     | 25     | M8          | Ø 12    |

### MAATWERK DIA 32MM (• Bestelformulier, zie achter in brochure)

| maat A        | maat C | maat D | bevestiging | boorgat |
|---------------|--------|--------|-------------|---------|
| tot max. 2000 | 80     | 32     | M8          | Ø 12    |

### MAATWERK DIA 38MM (• Bestelformulier, zie achter in brochure)

| maat A        | maat C | maat D | bevestiging | boorgat |
|---------------|--------|--------|-------------|---------|
| tot max. 2400 | 90     | 38     | M8          | Ø 12    |

### MAATWERK DIA 50MM (• Bestelformulier, zie achter in brochure)

| maat A        | maat C | maat D | bevestiging | boorgat |
|---------------|--------|--------|-------------|---------|
| tot max. 2600 | 100    | 50     | M8          | Ø 12    |

# DEURGREPEN

## DOORGEZETTE GREEP, TYPE 090

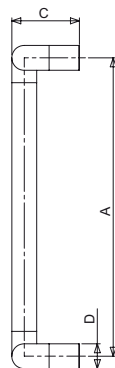
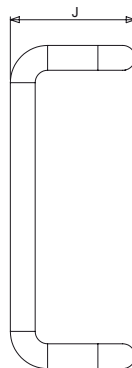

### STANDAARD DIA 19MM

|            |      | A   | C  | D  | J  | bevestiging | boorgat |
|------------|------|-----|----|----|----|-------------|---------|
| 1003045560 | stuk | 300 | 65 | 19 | 92 | M6          | Ø 10    |
| 1003045561 | paar | 300 | 65 | 19 | 92 | M6          | Ø 10    |

### MAATWERK DIA 19MM (• Bestelformulier, zie achter in brochure)

| maat A       | maat A       | maat C | maat D | maat J | bevestiging | boorgat |
|--------------|--------------|--------|--------|--------|-------------|---------|
| tot min. 175 | tot max. 600 | 65     | 19     | 92     | M6          | Ø 10    |

### STANDAARD DIA 25MM

|            |      | A   | C  | D  | J   | bevestiging | boorgat |
|------------|------|-----|----|----|-----|-------------|---------|
| 1003045570 | stuk | 300 | 75 | 25 | 117 | M8          | Ø 12    |
| 1003045571 | paar | 300 | 75 | 25 | 117 | M8          | Ø 12    |

### MAATWERK DIA 25MM (• Bestelformulier, zie achter in brochure)

| maat A       | maat A       | maat C | maat D | maat J | bevestiging | boorgat |
|--------------|--------------|--------|--------|--------|-------------|---------|
| tot min. 200 | tot max. 800 | 75     | 25     | 117    | M8          | Ø 12    |

### STANDAARD DIA 32MM

|            |      | A   | C  | D  | J   | bevestiging | boorgat |
|------------|------|-----|----|----|-----|-------------|---------|
| 1003045580 | stuk | 300 | 80 | 32 | 163 | M8          | Ø 12    |
| 1003045581 | paar | 300 | 80 | 32 | 163 | M8          | Ø 12    |

### MAATWERK DIA 32MM (• Bestelformulier, zie achter in brochure)

| maat A       | maat A        | maat C | maat D | maat J | bevestiging | boorgat |
|--------------|---------------|--------|--------|--------|-------------|---------|
| tot min. 250 | tot max. 1000 | 80     | 32     | 163    | M8          | Ø 12    |

# DEURGREPEN

## V-GREEP, TYPE 084

**NECOSTEEL**<sup>®</sup>  
RVS BESLAG  
opendek merk van vanaa

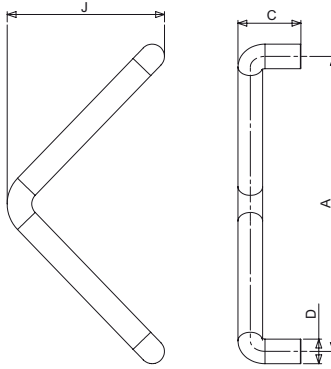
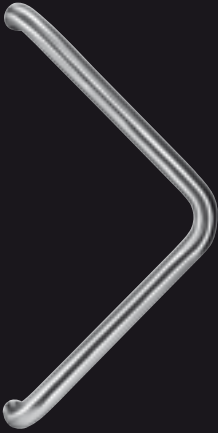

### STANDAARD DIA 19MM

|            |      | A   | C  | D  | J   | bevestiging | boorgat |
|------------|------|-----|----|----|-----|-------------|---------|
| 1003045640 | stuk | 300 | 53 | 19 | 169 | M6          | Ø 10    |
| 1003045641 | paar | 300 | 53 | 19 | 169 | M6          | Ø 10    |

### MAATWERK DIA 19MM (• Bestelformulier, zie achter in brochure)

| maat A       | maat A       | maat C | maat D | maat J | bevestiging | boorgat |
|--------------|--------------|--------|--------|--------|-------------|---------|
| tot min. 225 | tot max. 300 | 65     | 19     | -      | M6          | Ø 10    |

### STANDAARD DIA 25MM

|            |      | A   | C  | D  | J   | bevestiging | boorgat |
|------------|------|-----|----|----|-----|-------------|---------|
| 1003045650 | stuk | 300 | 64 | 25 | 185 | M8          | Ø 12    |
| 1003045651 | paar | 300 | 64 | 25 | 185 | M8          | Ø 12    |

### MAATWERK DIA 25MM (• Bestelformulier, zie achter in brochure)

| maat A       | maat A       | maat C | maat D | maat J | bevestiging | boorgat |
|--------------|--------------|--------|--------|--------|-------------|---------|
| tot min. 250 | tot max. 400 | 75     | 25     | -      | M8          | Ø 12    |

### STANDAARD DIA 32MM

|            |      | A   | C  | D  | J   | bevestiging | boorgat |
|------------|------|-----|----|----|-----|-------------|---------|
| 1003045660 | stuk | 300 | 75 | 32 | 182 | M8          | Ø 12    |
| 1003045661 | paar | 300 | 75 | 32 | 182 | M8          | Ø 12    |

### MAATWERK DIA 32MM (• Bestelformulier, zie achter in brochure)

| maat A       | maat A       | maat C | maat D | maat J | bevestiging | boorgat |
|--------------|--------------|--------|--------|--------|-------------|---------|
| tot min. 275 | tot max. 500 | 80     | 32     | -      | M8          | Ø 12    |

BIJ MAATWERK IS DE J MAAT AFHANKELIJK VAN MAAT A. J MAAT IS TE BEREKENEN ALS VOLGT:  
A MAAT X 0.5 + DIAMETER VAN DE GREEP = J MAAT.

# DEURGREPEN

## HALFRONDE GREEP, TYPE 093

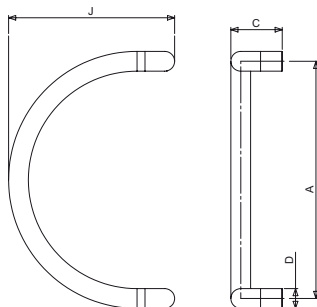
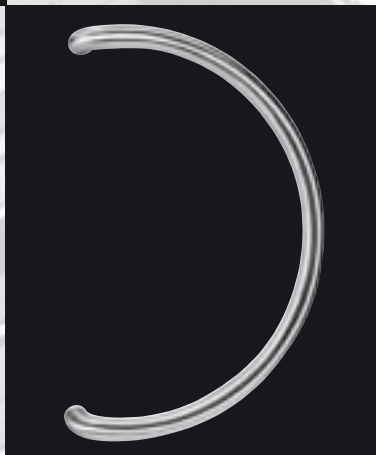

### STANDAARD DIA 19MM

|            |      | A   | C  | D  | J   | bevestiging | boorgat |
|------------|------|-----|----|----|-----|-------------|---------|
| 1003045530 | stuk | 300 | 56 | 19 | 219 | M6          | Ø 10    |
| 1003045531 | paar | 300 | 56 | 19 | 219 | M6          | Ø 10    |

### STANDAARD DIA 25MM

|            |      | A   | C  | D  | J   | bevestiging | boorgat |
|------------|------|-----|----|----|-----|-------------|---------|
| 1003045540 | stuk | 300 | 65 | 25 | 235 | M8          | Ø 12    |
| 1003045541 | paar | 300 | 65 | 25 | 235 | M8          | Ø 12    |

### STANDAARD DIA 32MM

|            |      | A   | C  | D  | J   | bevestiging | boorgat |
|------------|------|-----|----|----|-----|-------------|---------|
| 1003045550 | stuk | 300 | 87 | 32 | 255 | M8          | Ø 12    |
| 1003045551 | paar | 300 | 87 | 32 | 255 | M8          | Ø 12    |

# DEURGREPEN

## S-GREEP, TYPE 082

**NECOSTEEL**<sup>®</sup>  
RVS BESLAG  
Spierdenk merk van Knaag

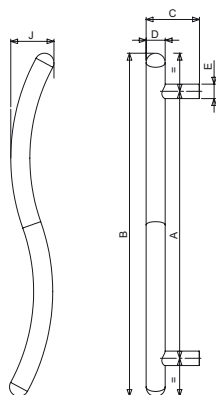

### STANDAARD DIA 25MM

|            |      | A   | B   | C  | D  | E  | J  | bevestiging | boorgat |
|------------|------|-----|-----|----|----|----|----|-------------|---------|
| 1003045740 | stuk | 350 | 450 | 68 | 25 | 20 | 60 | M8          | Ø 12    |
| 1003045741 | paar | 350 | 450 | 68 | 25 | 20 | 60 | M8          | Ø 12    |

### STANDAARD DIA 32MM

|            |      | A   | B   | C  | D  | E  | J  | bevestiging | boorgat |
|------------|------|-----|-----|----|----|----|----|-------------|---------|
| 1003045750 | stuk | 750 | 830 | 72 | 32 | 25 | 70 | M8          | Ø 12    |
| 1003045751 | paar | 750 | 830 | 72 | 32 | 25 | 70 | M8          | Ø 12    |

# DEURGREPEN

## T-GEBOGEN GREEP, TYPE 080

Als de A-maat het aanbevolen maximum overschrijdt, adviseren wij een extra steun toe te passen.

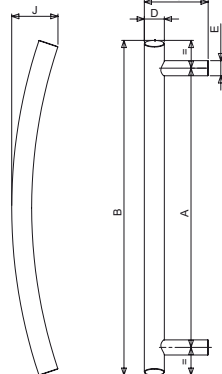

### MAATWERK DIA 19MM (• Bestelformulier, zie achter in brochure)

| maat A       | maat B   | maat C | maat D | maat E | maat J | radius       | bevestiging | boorgat |
|--------------|----------|--------|--------|--------|--------|--------------|-------------|---------|
| tot max. 600 | variabel | 54     | 19     | 18     | 58     | tot min. 200 | M6          | Ø 10    |

### STANDAARD DIA 25MM

|            | A    | B   | C   | D  | E  | J  | bevestiging | boorgat |      |
|------------|------|-----|-----|----|----|----|-------------|---------|------|
| 1003045780 | Stuk | 350 | 420 | 68 | 25 | 19 | 58          | M8      | Ø 12 |
| 1003045781 | Paar | 350 | 420 | 68 | 25 | 19 | 58          | M8      | Ø 12 |
| 1003045782 | stuk | 620 | 665 | 68 | 25 | 19 | 65          | M8      | Ø 12 |
| 1003045783 | paar | 620 | 665 | 68 | 25 | 19 | 65          | M8      | Ø 12 |

### MAATWERK DIA 25MM (• Bestelformulier, zie achter in brochure)

| maat A       | maat B   | maat C | maat D | maat E | maat J | radius       | bevestiging | boorgat |
|--------------|----------|--------|--------|--------|--------|--------------|-------------|---------|
| tot max. 600 | variabel | 68     | 25     | 20     | 58     | tot min. 275 | M8          | Ø 12    |

### MAATWERK DIA 32MM (• Bestelformulier, zie achter in brochure)

| maat A       | maat B   | maat C | maat D | maat E | maat J | radius       | bevestiging | boorgat |
|--------------|----------|--------|--------|--------|--------|--------------|-------------|---------|
| tot max. 800 | variabel | 72     | 32     | 25     | 65     | tot min. 400 | M8          | Ø 12    |

### MAATWERK DIA 38MM (• Bestelformulier, zie achter in brochure)

| maat A        | maat B   | maat C | maat D | maat E | maat J | radius       | bevestiging | boorgat |
|---------------|----------|--------|--------|--------|--------|--------------|-------------|---------|
| tot max. 1000 | variabel | 90     | 38     | 30     | 65     | tot min. 600 | M8          | Ø 12    |

### MAATWERK DIA 50MM (• Bestelformulier, zie achter in brochure)

| maat A        | maat B   | maat C | maat D | maat E | maat J | radius       | bevestiging | boorgat |
|---------------|----------|--------|--------|--------|--------|--------------|-------------|---------|
| tot max. 1200 | variabel | 102    | 50     | 30     | 65     | tot min. 800 | M8          | Ø 12    |

# DEURGREPEN

## U GEBOGEN GREEP, TYPE 070

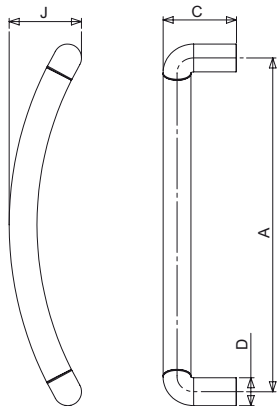

### MAATWERK DIA 19MM (• Bestelformulier, zie achter in brochure)

| maat A       | maat B   | maat C | maat D | maat J | radius       | bevestiging | boorgat |
|--------------|----------|--------|--------|--------|--------------|-------------|---------|
| tot max. 800 | variabel | 65     | 19     | 65     | tot min. 200 | M6          | Ø 10    |

### STANDAARD DIA 25MM

|            |      | A   | C  | D  | J  | bevestiging | boorgat |
|------------|------|-----|----|----|----|-------------|---------|
| 1003045700 | stuk | 300 | 66 | 25 | 65 | M8          | Ø 12    |
| 1003045701 | paar | 300 | 66 | 25 | 65 | M8          | Ø 12    |

### MAATWERK DIA 25MM (• Bestelformulier, zie achter in brochure)

| maat A        | maat B   | maat C | maat D | maat J | radius       | bevestiging | boorgat |
|---------------|----------|--------|--------|--------|--------------|-------------|---------|
| tot max. 1300 | variabel | 75     | 25     | 65     | tot min. 275 | M8          | Ø 12    |

### STANDAARD DIA 32MM

|            |      | A   | C  | D  | J  | bevestiging | boorgat |
|------------|------|-----|----|----|----|-------------|---------|
| 1003045710 | stuk | 300 | 74 | 32 | 65 | M8          | Ø 12    |
| 1003045711 | paar | 300 | 74 | 32 | 65 | M8          | Ø 12    |

### MAATWERK DIA 32MM (• Bestelformulier, zie achter in brochure)

| maat A        | maat B   | maat C | maat D | maat J | radius       | bevestiging | boorgat |
|---------------|----------|--------|--------|--------|--------------|-------------|---------|
| tot max. 1500 | variabel | 80     | 32     | 65     | tot min. 400 | M8          | Ø 12    |

### MAATWERK DIA 38MM (• Bestelformulier, zie achter in brochure)

| maat A        | maat B   | maat C | maat D | maat J | radius       | bevestiging | boorgat |
|---------------|----------|--------|--------|--------|--------------|-------------|---------|
| tot max. 1800 | variabel | 90     | 38     | 65     | tot min. 600 | M8          | Ø 12    |

# DEURGREPEN

## U90 GEBOGEN GREEP, TYPE 071

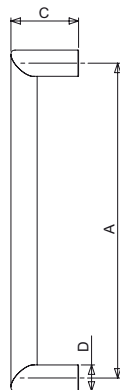

### MAATWERK DIA 19MM (• Bestelformulier, zie achter in brochure)

| maat A       | maat B   | maat C | maat D | maat J | radius       | bevestiging | boorgat |
|--------------|----------|--------|--------|--------|--------------|-------------|---------|
| tot max. 800 | variabel | 65     | 19     | 65     | tot min. 200 | M6          | Ø 10    |

### MAATWERK DIA 25MM (• Bestelformulier, zie achter in brochure)

| maat A        | maat B   | maat C | maat D | maat J | radius       | bevestiging | boorgat |
|---------------|----------|--------|--------|--------|--------------|-------------|---------|
| tot max. 1300 | variabel | 75     | 25     | 65     | tot min. 275 | M8          | Ø 12    |

### STANDAARD DIA 32MM

|            | A    | C   | D  | J  | bevestiging | boorgat    |
|------------|------|-----|----|----|-------------|------------|
| 1003045696 | stuk | 300 | 68 | 32 | 90          | M8<br>Ø 12 |
| 1003045697 | paar | 300 | 68 | 32 | 90          | M8<br>Ø 12 |

### MAATWERK DIA 32MM (• Bestelformulier, zie achter in brochure)

| maat A        | maat B   | maat C | maat D | maat J | radius       | bevestiging | boorgat |
|---------------|----------|--------|--------|--------|--------------|-------------|---------|
| tot max. 1500 | variabel | 80     | 32     | 65     | tot min. 400 | M8          | Ø 12    |

### MAATWERK DIA 38MM (• Bestelformulier, zie achter in brochure)

| maat A        | maat B   | maat C | maat D | maat J | radius       | bevestiging | boorgat |
|---------------|----------|--------|--------|--------|--------------|-------------|---------|
| tot max. 1800 | variabel | 90     | 38     | 65     | tot min. 600 | M8          | Ø 12    |

### MAATWERK DIA 50MM (• Bestelformulier, zie achter in brochure)

| maat A        | maat B   | maat C | maat D | maat J | radius       | bevestiging | boorgat |
|---------------|----------|--------|--------|--------|--------------|-------------|---------|
| tot max. 2000 | variabel | 100    | 50     | 65     | tot min. 800 | M8          | Ø 12    |

# DEURGREPEN

## T-DOORGEZETTE GREEP, TYPE 081

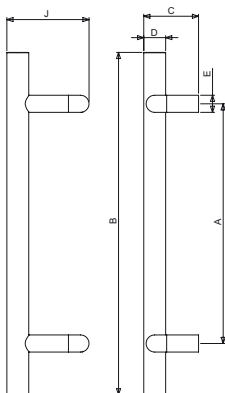

Als de A-maat het aanbevolen maximum overschrijdt, adviseren wij een extra steun toe te passen.

### STANDAARD DIA 32MM

|            |      | A   | B   | C  | D  | E  | J   | bevestiging | boorgat |
|------------|------|-----|-----|----|----|----|-----|-------------|---------|
| 1003045786 | stuk | 300 | 500 | 80 | 32 | 25 | 120 | M8          | Ø 12    |
| 1003045787 | paar | 300 | 500 | 80 | 32 | 25 | 120 | M8          | Ø 12    |

### MAATWERK DIA 32MM (• Bestelformulier, zie achter in brochure)

| maat A        | maat B   | maat C | maat D | maat E | maat J | bevestiging | boorgat |
|---------------|----------|--------|--------|--------|--------|-------------|---------|
| tot max. 1100 | variabel | 80     | 32     | 25     | 120    | M8          | Ø 12    |

# DEURGREPEN

## WP GREPEN, TYPE 077

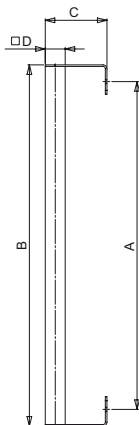
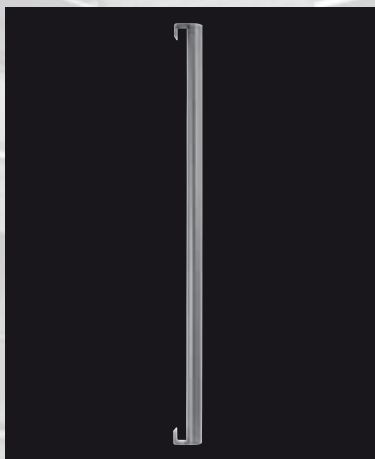

### MAATWERK DIA 32MM (• Bestelformulier, zie achter in brochure)

| maat A        | maat B    | maat C | maat D | bevestiging | boorgat |
|---------------|-----------|--------|--------|-------------|---------|
| tot max. 2000 | is A + 42 | 64     | 32     | M8          | Ø 12    |

### MAATWERK DIA 38MM (• Bestelformulier, zie achter in brochure)

| maat A        | maat B    | maat C | maat D | bevestiging | boorgat |
|---------------|-----------|--------|--------|-------------|---------|
| tot max. 2400 | is A + 42 | 70     | 38     | M8          | Ø 12    |

### MAATWERK DIA 50MM (• Bestelformulier, zie achter in brochure)

| maat A        | maat B    | maat C | maat D | bevestiging | boorgat |
|---------------|-----------|--------|--------|-------------|---------|
| tot max. 2800 | is A + 42 | 82     | 50     | M8          | Ø 12    |

# DEURGREPEN

## GEBOGEN RECHTE GREEP

Bij montage op hout of kunststof  
 adviseren wij een drukverdeelrozet  
 te gebruiken.

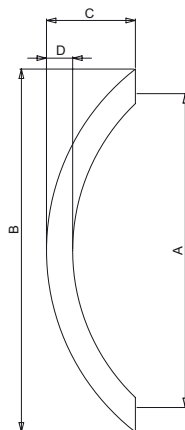

STANDAARD DIA 25MM

|            |      | A   | C  | D  | bevestiging | boorgat |
|------------|------|-----|----|----|-------------|---------|
| 1003045720 | stuk | 300 | 85 | 25 | M10         | Ø 14    |
| 1003045721 | paar | 300 | 85 | 25 | M10         | Ø 14    |

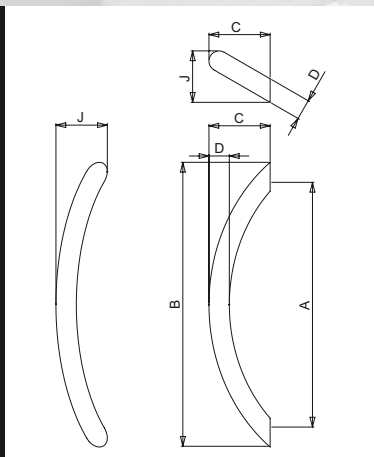

# DEURGREPEN

## GEBOGEN GEKANTELTE GREEP

STANDAARD DIA 25MM

|            |      | A   | C  | D  | J  | bevestiging | boorgat |
|------------|------|-----|----|----|----|-------------|---------|
| 1003045735 | stuk | 300 | 75 | 25 | 63 | M10         | Ø 14    |
| 1003045736 | paar | 300 | 75 | 25 | 63 | M10         | Ø 14    |

# DEURGREPEN

## T-KOKERGREEP

**NECOSTEEL**<sup>®</sup>  
RVS BESLAG  
opendek merk voor ranga

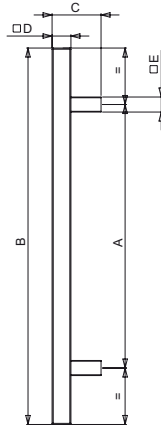

Als de A-maat het aanbevolen maximum overschrijdt, adviseren wij een extra steun toe te passen.

### MAATWERK DIA 20MM (• Bestelformulier, zie achter in brochure)

| maat A        | maat B   | maat C | maat D | maat E | bevestiging | boorgat |
|---------------|----------|--------|--------|--------|-------------|---------|
| tot max. 1000 | variabel | 65     | 20     | 18     | M8          | Ø 12    |

### MAATWERK DIA 25MM (• Bestelformulier, zie achter in brochure)

| maat A        | maat B   | maat C | maat D | maat E | bevestiging | boorgat |
|---------------|----------|--------|--------|--------|-------------|---------|
| tot max. 1500 | variabel | 70     | 25     | 20     | M8          | Ø 12    |

### MAATWERK DIA 30MM (• Bestelformulier, zie achter in brochure)

| maat A        | maat B   | maat C | maat D | maat E | bevestiging | boorgat |
|---------------|----------|--------|--------|--------|-------------|---------|
| tot max. 2000 | variabel | 80     | 30     | 25     | M8          | Ø 12    |

### MAATWERK DIA 40MM (• Bestelformulier, zie achter in brochure)

| maat A        | maat B   | maat C | maat D | maat E | bevestiging | boorgat |
|---------------|----------|--------|--------|--------|-------------|---------|
| tot max. 2400 | variabel | 90     | 40     | 30     | M8          | Ø 12    |

### MAATWERK DIA 50MM (• Bestelformulier, zie achter in brochure)

| maat A        | maat B   | maat C | maat D | maat E | bevestiging | boorgat |
|---------------|----------|--------|--------|--------|-------------|---------|
| tot max. 2800 | variabel | 100    | 50     | 30     | M8          | Ø 12    |

# DEURGREPEN

## U90-KOKER GREPEN

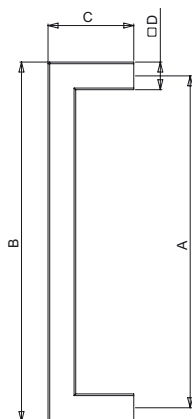
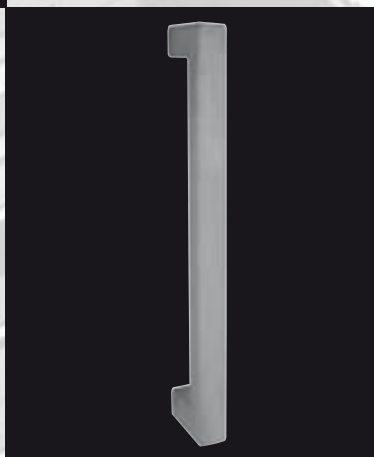

### STANDAARD DIA 19MM

|            |      | A   | C  | D  | bevestiging | boorgat |
|------------|------|-----|----|----|-------------|---------|
| 1003055670 | stuk | 200 | 59 | 19 | M8          | Ø 12    |
| 1003055671 | paar | 200 | 59 | 19 | M8          | Ø 12    |

### MAATWERK DIA 20MM (• Bestelformulier, zie achter in brochure)

| maat A        | maat C | maat D | bevestiging | boorgat |
|---------------|--------|--------|-------------|---------|
| tot max. 1000 | 65     | 20     | M6          | Ø 10    |

### STANDAARD DIA 25MM

|            |      | A   | C  | D  | bevestiging | boorgat |
|------------|------|-----|----|----|-------------|---------|
| 1003055680 | stuk | 300 | 69 | 25 | M8          | Ø 12    |
| 1003055681 | paar | 300 | 69 | 25 | M8          | Ø 12    |

### MAATWERK DIA 25MM (• Bestelformulier, zie achter in brochure)

| maat A        | maat C | maat D | bevestiging | boorgat |
|---------------|--------|--------|-------------|---------|
| tot max. 1500 | 75     | 25     | M8          | Ø 12    |

### MAATWERK DIA 30MM (• Bestelformulier, zie achter in brochure)

| maat A        | maat C | maat D | bevestiging | boorgat |
|---------------|--------|--------|-------------|---------|
| tot max. 2000 | 80     | 30     | M8          | Ø 12    |

### STANDAARD DIA 32MM

|            |      | A   | C  | D  | bevestiging | boorgat |
|------------|------|-----|----|----|-------------|---------|
| 1003055690 | stuk | 300 | 69 | 32 | M8          | Ø 12    |
| 1003055691 | paar | 300 | 69 | 32 | M8          | Ø 12    |

### MAATWERK DIA 40MM (• Bestelformulier, zie achter in brochure)

| maat A        | maat C | maat D | bevestiging | boorgat |
|---------------|--------|--------|-------------|---------|
| tot max. 2400 | 90     | 40     | M8          | Ø 12    |

### MAATWERK DIA 50MM (• Bestelformulier, zie achter in brochure)

| maat A        | maat C | maat D | bevestiging | boorgat |
|---------------|--------|--------|-------------|---------|
| tot max. 2600 | 100    | 50     | M8          | Ø 12    |

# DEURGREPEN

## TYPE 075

**NECOSTEEL**<sup>®</sup>  
RVS BESLAG  
Ijzerwerk met een vleug



248 mm

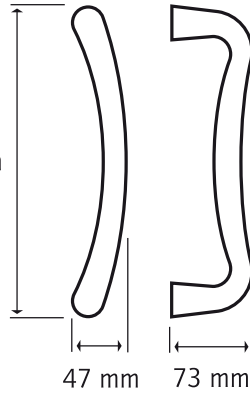

### STANDAARD

|            |                     |      |
|------------|---------------------|------|
| 1003045803 | NECO GREEP TYPE 075 | STUK |
| 1003045823 | NECO GREEP TYPE 075 | PAAR |

# DEURGREPEN

## TYPE 095

### STANDAARD

|            |                |      |
|------------|----------------|------|
| 1003045800 | GREEP TYPE 095 | STUK |
| 1003045820 | GREEP TYPE 095 | PAAR |



243 mm

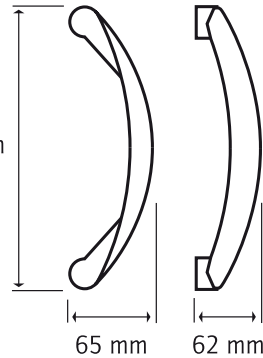

# DEURGREPEN TYPE 078

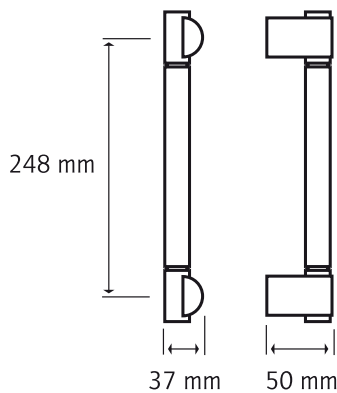
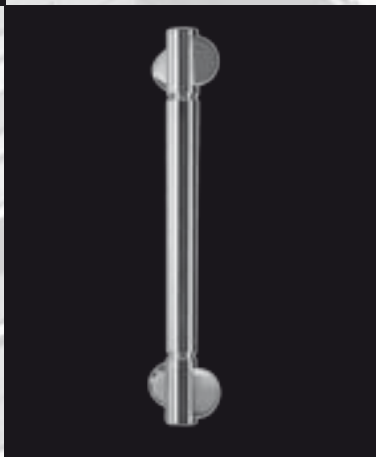

**STANDAARD**

|            |                     |      |
|------------|---------------------|------|
| 1003045806 | NECO GREEP TYPE 078 | STUK |
| 1003045826 | NECO GREEP TYPE 078 | PAAR |

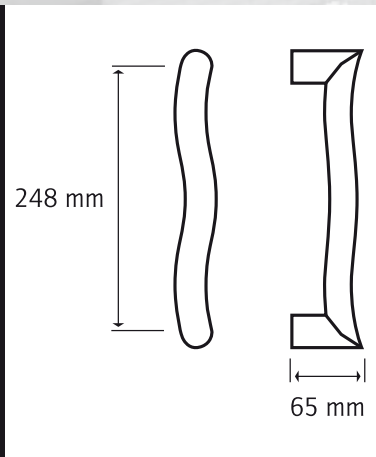

# DEURGREPEN TYPE 074

**STANDAARD**

|            |                     |      |
|------------|---------------------|------|
| 1003045802 | NECO GREEP TYPE 074 | STUK |
| 1003045822 | NECO GREEP TYPE 074 | PAAR |

# DEURGREPEN

## TYPE 073

**NECOSTEEL**<sup>®</sup>  
RVS BESLAG  
Spierdenk meer van metaal



248 mm

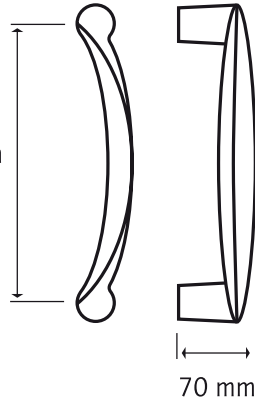

### STANDAARD

|            |                     |      |
|------------|---------------------|------|
| 1003045805 | NECO GREEP TYPE 073 | STUK |
| 1003045825 | NECO GREEP TYPE 073 | PAAR |

# DEURGREPEN

## TYPE 087

### STANDAARD

|            |                     |      |
|------------|---------------------|------|
| 1003045801 | NECO GREEP TYPE 087 | STUK |
| 1003045821 | NECO GREEP TYPE 087 | PAAR |



248 mm

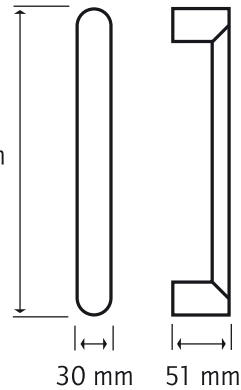

# DEURGREPEN

## TYPE 072

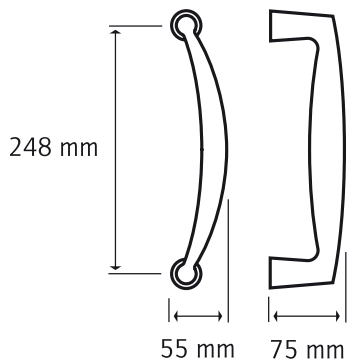

### STANDAARD

|            |                     |      |
|------------|---------------------|------|
| 1003045804 | NECO GREEP TYPE 072 | STUK |
| 1003045824 | NECO GREEP TYPE 072 | PAAR |

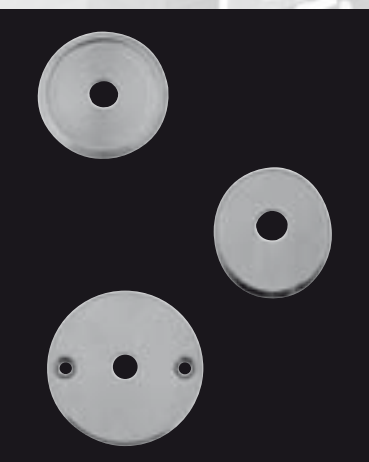

# DEURGREPEN

## DRUKVERDEEL

## ROZETTEN

## OPSCHROEFROZETTEN

### DRUKVERDEELROZETTEN

| Artikelnummer | Model                        |
|---------------|------------------------------|
| 1003005793    | NECO Ø 26 / M6               |
| 1003005794    | NECO Ø 32 / M8               |
| 1003005790    | NECO Ø 38 / M8               |
| 1003005791    | NECO Ø 50 / M8               |
| 1003005792    | NECO Ø 58 / M8               |
| 1003005795    | NECO OVAAL TBV T-SCHUIN Ø 25 |
| 1003005796    | NECO OVAAL TBV T-SCHUIN Ø 32 |

### OPSCHROEFROZETTEN

| Artikelnummer | Model          |
|---------------|----------------|
| 1003005797    | NECO Ø 26 / M6 |
| 1003005798    | NECO Ø 32 / M8 |
| 1003005799    | NECO Ø 38 / M8 |

# DEURGREPEN BEVESTIGINGEN

**NECOSTEEL**<sup>®</sup>  
RVS BESLAG  
*Spierdenk merk van Knaag*



DOORGAAND  
DD 15 GLAS

PAARSGEWIJS  
DD15 GLAS



DOORGAAND  
DD70 HOUT

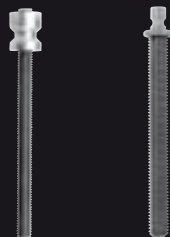

PAARSGEWIJS  
DD70 HOUT



BEVESTIGINGSBOUTEN  
VOOR BLINDE BEVESTIGINGEN

# DEURGREPEN BEVESTIGINGEN

| Type                   | Dia 19mm<br>Stuks | Dia 19mm<br>Paar | Dia 25mm<br>Stuks | Dia 25mm<br>Paar | Dia 32mm<br>Stuks | Dia 32mm<br>Paar | Dia 38mm<br>Stuks | Dia 38mm<br>Paar | Dia 40mm<br>Stuks | Dia 40mm<br>Paar | Dia 50mm<br>Stuks | Dia 50mm<br>Paar |
|------------------------|-------------------|------------------|-------------------|------------------|-------------------|------------------|-------------------|------------------|-------------------|------------------|-------------------|------------------|
| T-vorm                 |                   |                  |                   |                  |                   |                  |                   |                  |                   |                  |                   |                  |
| dd 15                  | 1011001040        | 1011001042       | 1011001044        | 1011001046       | 1011001048        | 1011001050       | 1011001048        | 1011001050       | -                 | -                | 1011001048        | 1011001050       |
| dd 70                  | 1011001041        | 1011001043       | 1011001045        | 1011001047       | 1011001049        | 1011001051       | 1011001049        | 1011001051       | -                 | -                | 1011001049        | 1011001051       |
| T-schuin vorm          |                   |                  |                   |                  |                   |                  |                   |                  |                   |                  |                   |                  |
| dd 70                  | -                 | -                | 1011001034        | 1011001035       | 1011001037        | 1011001038       | -                 | -                | -                 | -                | -                 | -                |
| U-vorm                 |                   |                  |                   |                  |                   |                  |                   |                  |                   |                  |                   |                  |
| dd 15                  | 1011001040        | 1011001042       | 1011001044        | 1011001046       | 1011001048        | 1011001050       | -                 | -                | 1011001052        | 1011001054       | -                 | -                |
| dd 70                  | 1011001041        | 1011001043       | 1011001045        | 1011001047       | 1011001049        | 1011001051       | -                 | -                | 1011001053        | 1011001055       | -                 | -                |
| U90°                   |                   |                  |                   |                  |                   |                  |                   |                  |                   |                  |                   |                  |
| dd 15                  | 1011001040        | 1011001042       | 1011001044        | 1011001046       | 1011001048        | 1011001050       | -                 | -                | 1011001052        | 1011001054       | -                 | -                |
| dd 70                  | 1011001041        | 1011001043       | 1011001045        | 1011001047       | 1011001049        | 1011001051       | -                 | -                | 1011001053        | 1011001055       | -                 | -                |
| Doorgezette grepen     |                   |                  |                   |                  |                   |                  |                   |                  |                   |                  |                   |                  |
| dd 15                  | 1011001040        | 1011001042       | 1011001044        | 1011001046       | 1011001048        | 1011001050       | -                 | -                | -                 | -                | -                 | -                |
| dd 70                  | 1011001041        | 1011001043       | 1011001045        | 1011001047       | 1011001049        | 1011001051       | -                 | -                | -                 | -                | -                 | -                |
| T-D schuin met bochten |                   |                  |                   |                  |                   |                  |                   |                  |                   |                  |                   |                  |
| dd 15                  | -                 | -                | 1011001044        | 1011001046       | -                 | -                | -                 | -                | -                 | -                | -                 | -                |
| dd 70                  | -                 | -                | 1011001045        | 1011001047       | -                 | -                | -                 | -                | -                 | -                | -                 | -                |

| Blinde bevestiging voor |            |
|-------------------------|------------|
| T-schuin                | 1011001036 |
| geb-gek en geb-recht    | 1011001036 |
| T-gr                    | 1011001033 |
| U-gr                    | 1011001033 |
| U90-gr                  | 1011001033 |
| D-gr                    | 1011001033 |
| T-D gr                  | 1011001033 |

**NECOSTEEL GREPEN ZIJN ALTIJD INCLUSIEF DOORGAANDE BEVESTIGING.**

# ALGEMENE INFORMATIE

## ONDERHOUDSADVIES

Al het NECOSTEEL deurbeslag is gemaakt van roestvast staal. Maar wat is nu eigenlijk roestvast staal? En hoe dien je het te onderhouden voor buiten gebruik?

## WAT IS RVS?

RVS of roestvast staal is de verzamelnaam van een aantal ijzerlegeringen met een minimum van 10,5% chroom en een laag koolstofgehalte. RVS beschikt over zeer hoge corrosiewerende eigenschappen en is daarom duurzaam en eenvoudig te onderhouden.

## ONDERHOUD EN REINIGING TIPS

Gebruik nooit staalwol of een staalborstel.

Het afzemen met zuiver water is de simpelste, veiligste en goedkoopste manier om het RVS te reinigen. Een zachte doek en schoon warm water vormen de beste methode voor het verwijderen van niet te ernstige vlekken, of los vuil en stof.

RVS heeft geen last van slijtage als gevolg van het overmatig reinigen. RVS-oppervlakten varen wel bij het frequent schoonmaken, want er is geen sprake van een deklaag, die kan afslijten.

Voor langdurig onderhoud bevelen wij onze Ivana RVS Cleaner aan.

Voor goed advies betreffende diverse RVS producten raden wij u aan contact op te nemen met uw NECOSTEEL dealer.

## MATERIAALOMSCHRIJVING

1. Het NECOSTEEL programma wordt vervaardigd uit hoogwaardig RVS Aisi 304 DIN W-nr 143.01. Deze kwaliteit is uitzonderlijk goed bestand tegen atmosferische corrosie.
2. Al deze producten worden geslepen op korrel 320 en vervolgens zijdeglans geborsteld. Dit is ruim voldoende voor een buitentoepassing.

## OVERIGE INFORMATIE

1. Alle afmetingen die zijn opgenomen in de catalogus, staan vermeld in mm.
2. Om voldoende stabiliteit te kunnen garanderen, raden wij de gebruiker aan om, vanaf bepaalde asmaten, een extra steunpunt te gebruiken. Deze asmaten staan aangegeven bij elke greep info m.b.t. maten.
3. Het bestelformulier treft u aan achter in dit boekwerk.
4. Standaard artikelen uit voorraad leverbaar. Maatwerk artikelen levertijd 3 weken.

# BESTELFORMULIER MAATWERK

FIRMA NAAM: ..... DATUM: .....

ORDERNUMMER: ..... DEURDIKTE: .....

BESTELD/AANGEVRAAGD DOOR: .....

OPMERKINGEN: .....

| TYPE                       | ASMAAT | TOTALE LENGTE | STUKS                    | PAAR                     | AANTAL |
|----------------------------|--------|---------------|--------------------------|--------------------------|--------|
| T GREEP                    | .....  | .....         | <input type="checkbox"/> | <input type="checkbox"/> | .....  |
| T-SCHUIN GREEP             | .....  | .....         | <input type="checkbox"/> | <input type="checkbox"/> | .....  |
| U GREEP                    | .....  | N.V.T.        | <input type="checkbox"/> | <input type="checkbox"/> | .....  |
| U90 GREEP                  | .....  | N.V.T.        | <input type="checkbox"/> | <input type="checkbox"/> | .....  |
| U-GEBOGEN GREEP (RADIUS)   | .....  | N.V.T.        | <input type="checkbox"/> | <input type="checkbox"/> | .....  |
| U90-GEBOGEN GREEP (RADIUS) | .....  | N.V.T.        | <input type="checkbox"/> | <input type="checkbox"/> | .....  |
| T-DOORGEZETTE GREEP        | .....  | .....         | <input type="checkbox"/> | <input type="checkbox"/> | .....  |

## DIAMETER

|                               |                               |                               |                               |                               |                                      |
|-------------------------------|-------------------------------|-------------------------------|-------------------------------|-------------------------------|--------------------------------------|
| <input type="checkbox"/> 19MM | <input type="checkbox"/> 25MM | <input type="checkbox"/> 32MM | <input type="checkbox"/> 38MM | <input type="checkbox"/> 50MM | <input type="checkbox"/> ANDERS..... |
|-------------------------------|-------------------------------|-------------------------------|-------------------------------|-------------------------------|--------------------------------------|

## BEVESTIGING

|                                      |   |                                  |   |  |
|--------------------------------------|---|----------------------------------|---|--|
| <input type="checkbox"/> 1 DOORGAAND | <input type="checkbox"/> 2 DOORGAAND GLAS | <input type="checkbox"/> 3 BLIND | <input type="checkbox"/> 4 PAARS-GEWIJZE GLAS | <input type="checkbox"/> 5 PAARS-GEWIJZE |
|--------------------------------------|---|----------------------------------|---|--|



**GUNTERS en MEUSER**  
IJZERWAREN, GEREEDSCHAPPEN, MACHINES, HANG- EN SLUITWERK

SINDS 1826

**AMSTERDAM**  
Egelantiersgracht 2-6  
1015 RL Amsterdam  
T: 020-6221666  
F: 020-6245444  
E: verkoopgracht@  
guntersenmeuser.nl

**AMSTERDAM SLOTERDIJK**  
Basisweg 59C  
1043 AN Amsterdam  
T: 020-6174315  
F: 020-6175143  
E: verkoopschinkel@  
guntersenmeuser.nl

**AMSTERDAM**  
J. van Hasseltweg 59  
1021 KN Amsterdam  
T: 020-6373131  
F: 020-6360900  
E: verkoopnoord@  
guntersenmeuser.nl

**AMSTERDAM Z-O**  
Lemelerbergweg 35G  
1101 AH Amsterdam Z-O  
T: 020-6174315  
F: 020-6175143  
E: verkoopschinkel@  
guntersenmeuser.nl

**AMSTERDAM**  
Laboratoriumstraat 9  
1059 BX Amsterdam  
T: 020-6174315  
F: 020-6175143  
E: verkoopschinkel@  
guntersenmeuser.nl

**ALMERE**  
Markerkant 15-06  
1314 AW Almere-Stad  
T: 036-5330444  
F: 036-5330374  
E: verkoopalmere@  
guntersenmeuser.nl